

Installation Instructions

INTRODUCTION

Proper coupling alignment is essential for trouble-free operation of open-motor direct drive compressors. These instructions cover angular and parallel alignment (Fig. 1) of

the compressor and motor shafts for the coupling packages listed in Table 1.

The maximum allowable angular and parallel misalignments are given in Table 2. A dial indicator **must** be used to properly align the compressor and motor shafts for reliable operation.

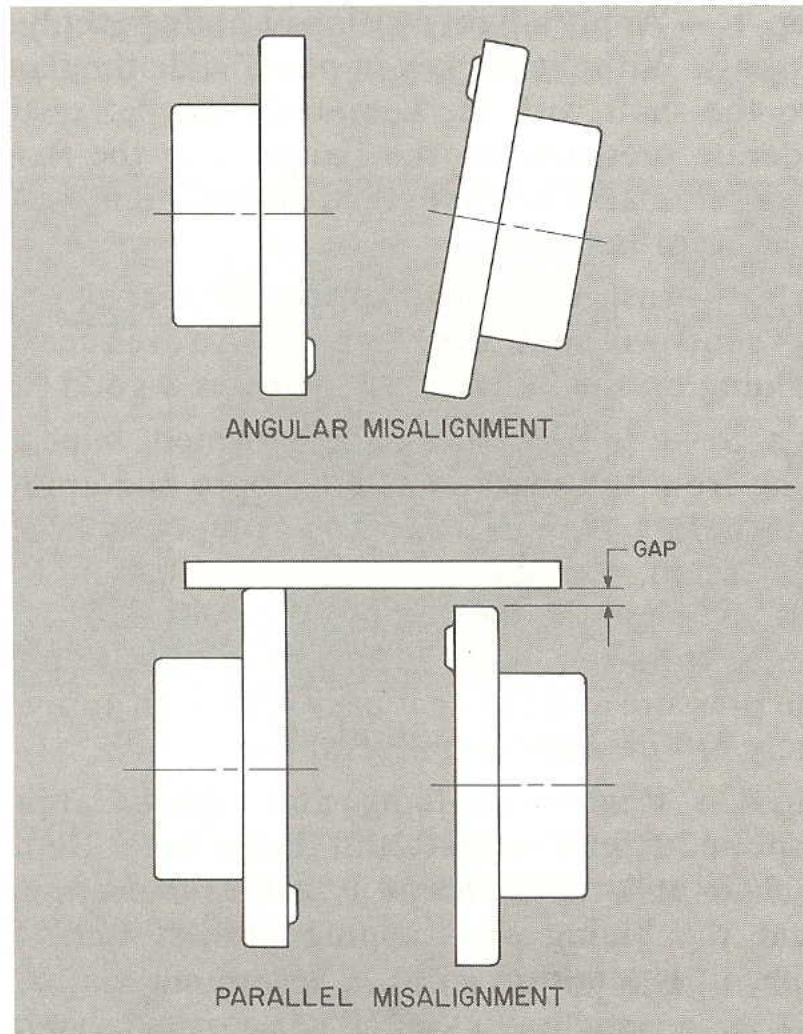

Fig. 1 – Types of Misalignment

Table 2 – Assembly and Alignment Data

COUPLING*		TOTAL INDICATOR READING (in.)		LOCKNUT TORQUE (lb-ft)†	DIMEN. "E"*** (in.)
Size	Type	Angular	Parallel		
163	DBZ-B	0.009	0.004	13	27/16
201		0.011	0.006	25	215/16
226		0.012	0.008	43	313/16
263		0.014	0.008	63	45/16
262	AMR	0.014	0.007	43	3 1/2
312		0.016	0.008	63	4 1/8

*Refer to Table 1, Rexnord Part No.

†Approximate tightening torque for lubricated locknuts.

**See Fig. 4.

Table 1 – Flexible Couplings for Direct Drive Units

CARRIER PACKAGE NO.	COMPRESSOR	MOTOR HP*	1965 NEMA FRAME	MOTOR SHAFT DIAM. (in.)*	MAX HP	REXNORD PART NO.
5F20-847	5F20, 30	7 1/2, 10	213T, 215T	1.375	11.5	163-DBZ-B
5F30-847		15, 20	254T, 256T	1.625	17.5	163-DBZ-B
5F40-603	5F40, 60	7 1/2, 10	213T, 215T	1.375	17.5	163-DBZ-B
5F40-623		15	254T	1.625	17.5	163-DBZ-B
5F60-623		20	256T	1.625	30.0	201-DBZ-B
5F60-613		25, 30	284T, 286T	1.875	34.5	201-DBZ-B
5H40-613	5H40, 46	20	256T	1.625	34.5	201-DBZ-B
5H60-613		25, 30	284T, 286T	1.875	65.0	201-DBZ-B
5H60-613		40, 50, 60	324TS, 326TS, 364TS	1.875	65.0	201-DBZ-B
5H60-623		40, 50	324T, 326T	2.125	65.0	201-DBZ-B
5H80-613		60	364T	2.375	86.0	226-DBZ-B
5H60-613	5H60, 66	30	286T	1.875	65.0	201-DBZ-B
5H60-613		40, 50, 60	324TS, 326TS, 364TS	1.875	65.0	201-DBZ-B
5H60-623		40, 50	324T, 326T	2.125	65.0	201-DBZ-B
5H80-613		60, 75	364T, 365T	2.375	86.0	226-DBZ-B
5H80-663		75	365TS	1.875	86.0	226-DBZ-B
5H120-623		100	404TS	2.125	150.0	262-AMR
5H60-613	5H80, 86	40, 50, 60	324TS, 326TS, 364TS	1.875	65.0	201-DBZ-B
5H60-623		40, 50	324T, 326T	2.125	65.0	201-DBZ-B
5H80-613		60, 75	364T, 365T	2.375	86.0	226-DBZ-B
5H80-663		75	365TS	1.875	86.0	226-DBZ-B
5H120-623		100	404TS, 405TS	2.125	150.0	262-AMR
5H60-613	5H120, 126	60	364TS	1.875	65.0	201-DBZ-B
5H80-613		60, 75	364T, 365T	2.375	86.0	226-DBZ-B
5H80-663		75	365TS	1.875	86.0	226-DBZ-B
5H120-623		100, 125	404TS, 405TS	2.125	150.0	262-AMR
5H126-623		150, 200	444TS, 445TS	2.375	200.0	312-AMR

*For correct coupling selection, refer to motor shaft diameter as well as motor horsepower. Using only horsepower data can be misleading.

Manufacturer reserves the right to discontinue, or change at any time, specifications or designs without notice and without incurring obligations.

PREPARATIONS

Before proceeding with the coupling installation, perform the following preparation procedure:

Step 1 — Be sure compressor and motor bases are clean and free of nicks and burrs and the equipment is seated firm and level. Tighten the compressor holddown bolts and dowel compressor to base (see Doweling, page 4).

Step 2 — Carefully check compressor and motor shafts and bores in the coupling flanges. These areas must be free of nicks and burrs.

Step 3 — Be sure keys fit keyways in the shafts and flange bores freely but without play.

Step 4 — Start the motor and lightly scribe a line around the shaft at the face of the bearing housing (see Fig. 2). This marks the running position of the shaft. If the motor cannot be run, measure the amount of shaft end play and lightly scribe a line around the shaft at half this measurement.

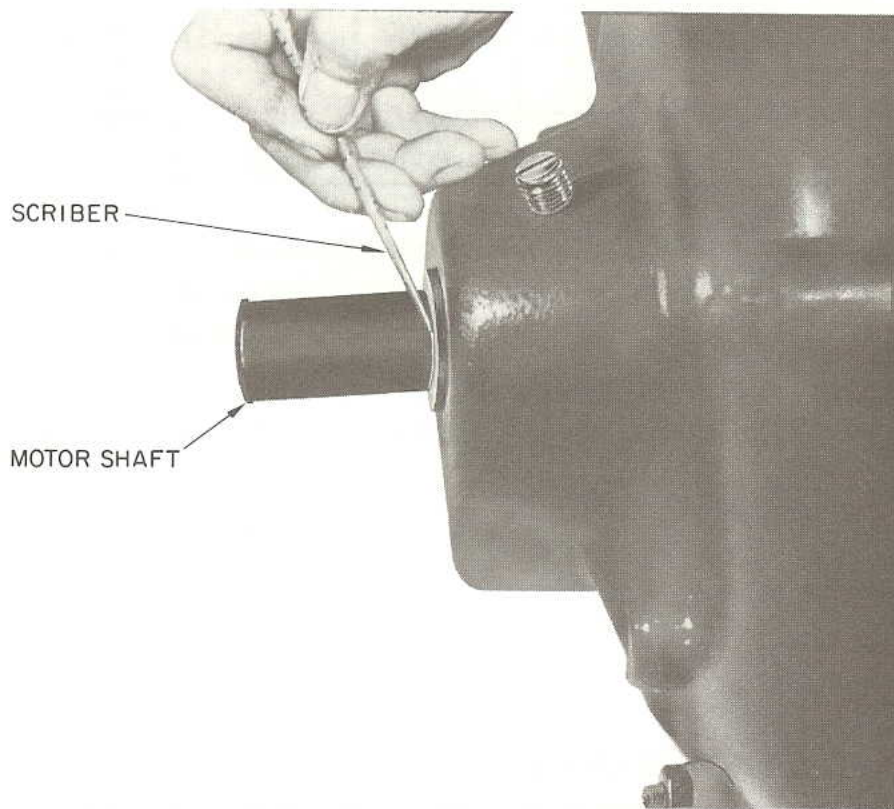

Fig. 2 — Scribing a Line to Indicate Running Position of Motor Shaft

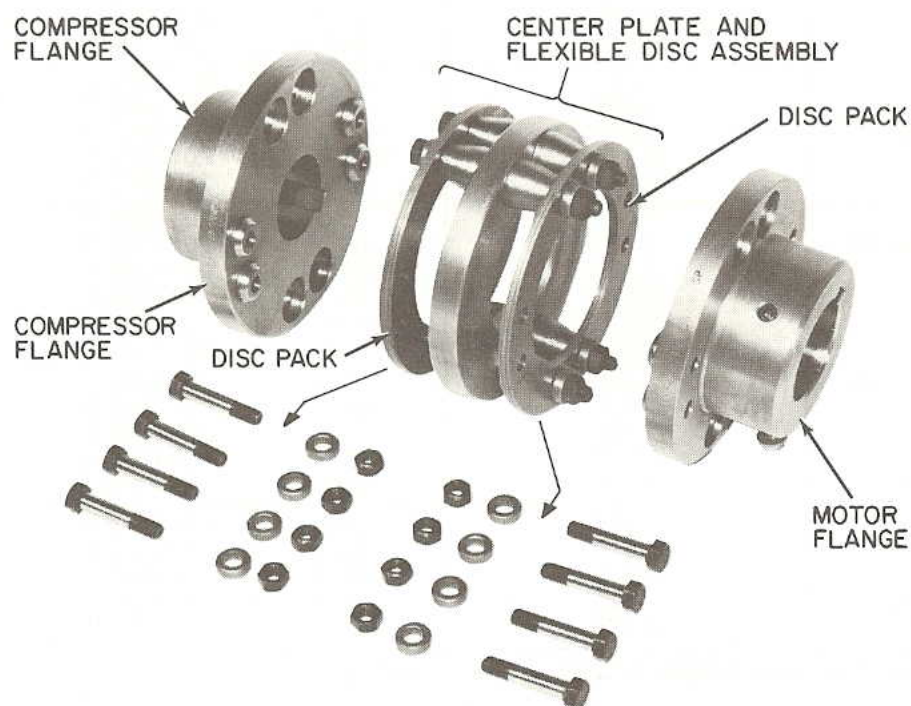

Fig. 3 — Disassembled Coupling

Step 5 — Disassemble the coupling as shown in Fig. 3. The center section comes out as a unit. *Do not disassemble the center section.*

INSTALLATION

Compressor Flange — This flange has a tapered bore to fit the taper on the compressor flange. *It is most important that the flange fits the shaft properly.* Because of normal machining variations between the shaft and bore tapers, the following procedure must be followed to attain a proper fit:

Step 1 — Apply a light coating of bluing evenly on the shaft. Without the key in place, slide the flange onto the shaft with the keyways aligned, exerting moderate pressure, on the flange. Tap the flange with a soft mallet to seat it, then carefully remove the flange from the shaft.

Step 2 — Inspect the shaft surface for irregularities. High spots will show as shiny areas. An even coating of bluing on the flange bore indicates a good fit.

Step 3 — If high spots are indicated, wipe the bluing from the shaft and flange bore and apply a light coating of FINE lapping compound to the shaft. Again, without the key in place, align the keyways and slide the flange onto the shaft as far as it will go. Hold the flange in this position with moderate pressure and rotate it back and forth approximately 1/4 in. each way several times.

Step 4 — Remove the flange and wipe the lapping compound from the shaft and flange bore. Reblue the shaft and repeat Steps 1 and 2. If necessary, repeat the bluing and lapping process until the proper fit is attained.

Step 5 — Wipe the shaft and bore clean and, with the keyways aligned, slide the flange onto the shaft as far as it will go with only moderate pressure. Note the position of the flange face with respect to the shaft end (the shaft end should be approximately 1/8 in. below the flange face). Remove the flange.

Step 6 — Place the key in the keyway and again slide the flange onto the shaft as far as it will go, as in Step 5. If the flange does not stop in the same position as before, the key is causing the misfit and must be carefully "dressed down" until the fit is correct (use a fine stone).

Step 7 — When the flange has been properly fitted, apply a coating of rust inhibitor to the shaft. With the key in place, slide the flange into position and install the washer and bolt provided with the compressor. Tighten to torque specified in Table 3.

Motor Flange — This flange has a straight bore. Be sure the key fits the shaft and bore keyways, snug but free, then apply a coating of rust inhibitor to the shaft. Slide the flange onto the shaft until the end of the shaft and the face of the flange are approximately flush (only moderate hand pressure should be required). Tighten the setscrews in the flange hub. *Leave the center section of the coupling out.*

**Table 3 — Torque Values
(Coupling Flange to Crankshaft)**

UNIT	BOLT SIZE (in.)	TORQUE (lb-ft)
5F 20, 30	3/4 - 16*	70 - 80
5F 40, 60	3/8 - 24	45 - 50
5H 40 - 126	5/8 - 18	80 - 90

*Locknut.

Axial Adjustment (Dimension "E," Fig. 4) — Set the motor shaft in running position as explained under Preparation, Step 4.

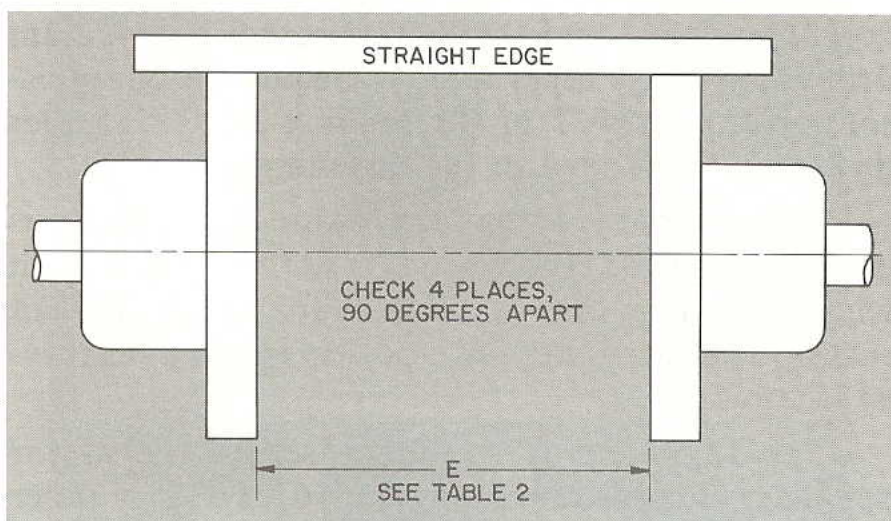

Fig. 4 — Preliminary Adjustment

With the compressor secured and doweled to the base, all adjustments are made by moving and shimming the motor.

Adjust the motor position as required until the distance between the flange faces (Dimension "E" in Table 2) is correct when measured at 4 points, 90 degrees apart (Fig. 4). When establishing Dimension "E", check the alignment of the flanges with a straight edge as shown in Fig. 4. *This is a preliminary check only. All final alignment must be by dial indicator.* Tighten the motor holddown bolts before proceeding further (securely, but not to specified torque as motor position will be adjusted in the alignment procedure). Final torquing will be done when alignment is complete.

Reinstall Center Section — Loosen the setscrews in motor flange hub and slide flange back on shaft to allow sufficient space for positioning the center section between flange faces. Using the bolts, nuts and washers removed when disassembled, reassemble center section to flanges. *The radius side of the washers must be against the disc pack.*

Step 1 — Bolt, finger tight, to the compressor flange.

Step 2 — Slide motor flange out on shaft and reset to Dimension "E" with motor shaft in running position established in Preparation, Step 4.

Step 3 — Bolt motor flange to center section, finger tight.

Step 4 — Tighten coupling locknuts securely but not to specified torque. Final torquing is done after alignment is complete. *When tightening, turn the nut, not the bolt.*

Step 5 — Tighten the two setscrews in the motor flange hub.

ALIGNMENT

Depending on where the indicator is mounted, a close parallel alignment may be apparent even when a bad angular misalignment exists. Therefore, always check angular alignment *first*.

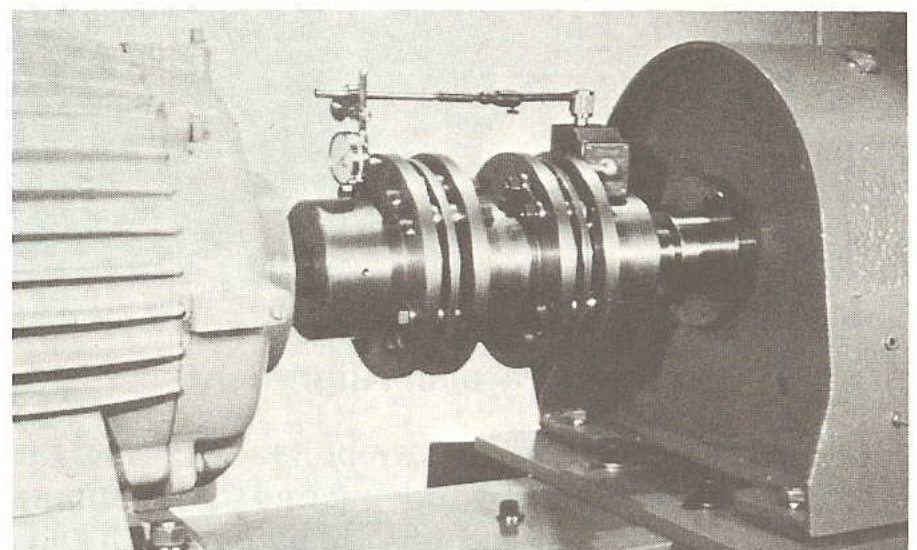

Fig. 5 — Set-Up for Checking Angular Alignment

Angular Adjustment — Set up the dial indicator as shown in Fig. 5. Depress the stem to approximate mid-stroke to allow needle movement in either direction. Rotate the connected shafts several revolutions until indicator fluctuation is consistent and then proceed in the same direction until the reading is minimum. Set the dial to zero and continue the rotation for 180 degrees. At this point the indicator shows the total angular misalignment. Loosen the motor holddown bolts and by moving and/or shimming, correct the angular misalignment.

Calculate thickness of shim required as follows:

- S = Thickness of shim required.
- L = Distance between front and rear holddown bolts in inches.
- D = Diameter of coupling in inches.
- M = Misalignment in inches.

$$S = \frac{ML}{D} \text{ or: } S = \frac{L}{D} \times M$$

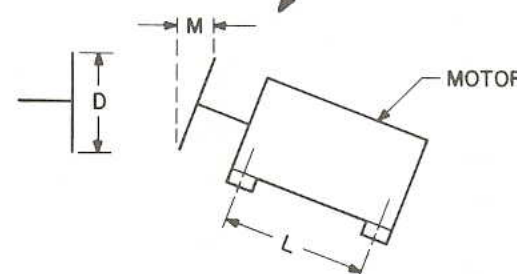

Retighten holddown bolts and recheck. Readjust the motor position, if necessary, until the total indicator reading is within the allowable variation shown in Table 2.

Recheck angular alignment until several repeated readings are consistent.

Parallel Alignment — Set up the dial indicator as shown in Fig. 6, with the indicator stem depressed to approximate mid-stroke. As in the previous check, rotate the connected shafts until a minimum dial reading is established. Set dial to zero and continue rotation 180 degrees. At this point the reading is *twice* the amount of parallel misalignment.

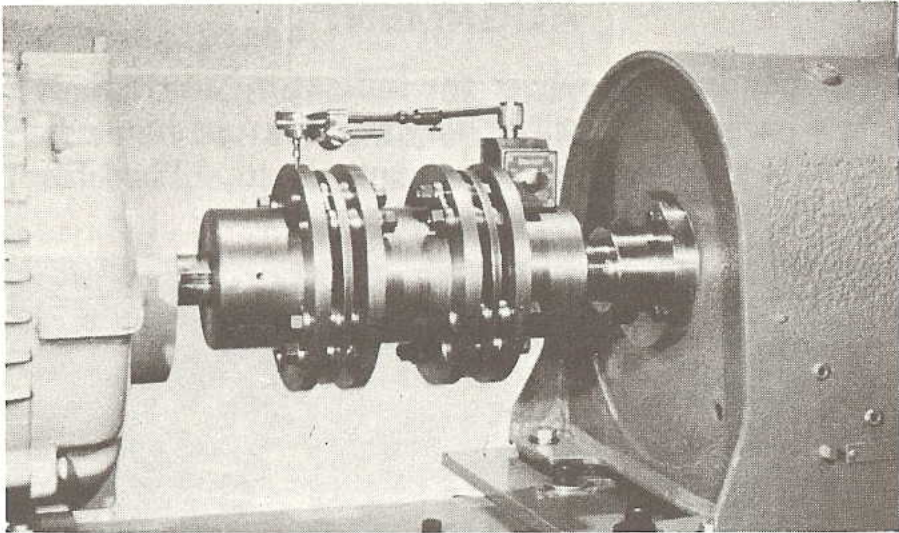

Fig. 6 — Set-Up for Checking Parallel Alignment

Loosen the motor holddown bolts and correct the parallel misalignment by moving and/or shimming (be sure same thickness shims are used at both ends of the motor). Righten holddown bolts and recheck both angular and parallel alignment. Readjust any remaining misalignment.

When all alignment corrections have been made, tighten coupling locknuts to the specified torque listed in Table 2.

Be sure setscrews in coupling motor hub are tight.
Be sure motor holddown bolts are tight.
Dowel motor to base (see Doweling).

Run the unit until normal operating temperature is established and recheck both angular and parallel alignment.

Periodically inspect the coupling visually for distortion or breakage of disc packs and replace when necessary.

DOWELING

Drill and ream 2 holes thru diagonally-opposite compressor feet and the base. Use a 9/32-in. diam drill and a No. 6 taper reamer. Secure the compressor position with 2 of the no. 6 x 2-1/2 in. taper dowel pins provided in the fastening kit.

Fit each dowel so that approximately 1/16-in. is projecting above the foot. Coat the dowels with white lead or other suitable lubricant to prevent rusting and tap lightly into position with a machinist's hammer.

After alignment is complete, secure the motor position using the remaining 2 no. 6 x 2-1/2 in. taper dowel pins provided in the fastening kit (dowel diagonally-opposite feet).

Be sure all dowels are tight and that they do not bottom. Tighten holddown bolts to proper torque.

Manufacturer reserves the right to discontinue, or change at any time, specifications or designs without notice and without incurring obligations.

Book 2 | 4 PC 802 Catalog No. 530-529 Printed in U.S.A. Form 5F,H-14SI Pg 4 1192 9-82 Replaces: New
Tab 2a | 3a